

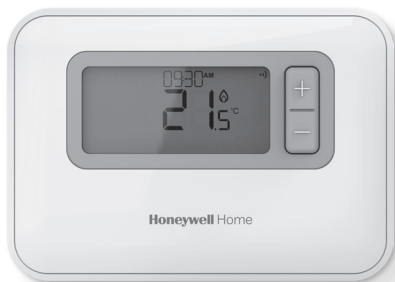

## T3, T3R, T3M Programmable Thermostat

EN User Guide



### T3

Programmable Thermostat

### T3M

Programmable Modulating  
Thermostat



### T3R

Wireless Programmable Thermostat

# Contents

1) Thermostat Interface .....	3
Screen and Button Overview .....	3
Status Icons.....	4
Menu & Navigation Icons.....	4
Navigating the Menu.....	4
2) Menu .....	5
Heating Schedule.....	5
Adjusting the Schedule .....	5
Copy Schedule.....	7
Delete Period .....	7
Settings (Date & Time).....	8
3) Device Modes .....	11
Automatic Operation (AUTO) .....	11
Temporary Override.....	11
+1hr Timed Override.....	11
Manual Operation (MAN).....	12
Permanent Override.....	12
Standby mode (with frost protect).....	13
4) Keypad Lock.....	14
5) Optimisation .....	15
6) Changing the Batteries (T3 & T3R only).....	16
7) Table Stand and Wall Mount (T3R only).....	17
8) Wireless Receiver Box (T3R only) .....	18
9) Troubleshooting .....	19

# 1 Thermostat Interface

## Screen and Button Overview

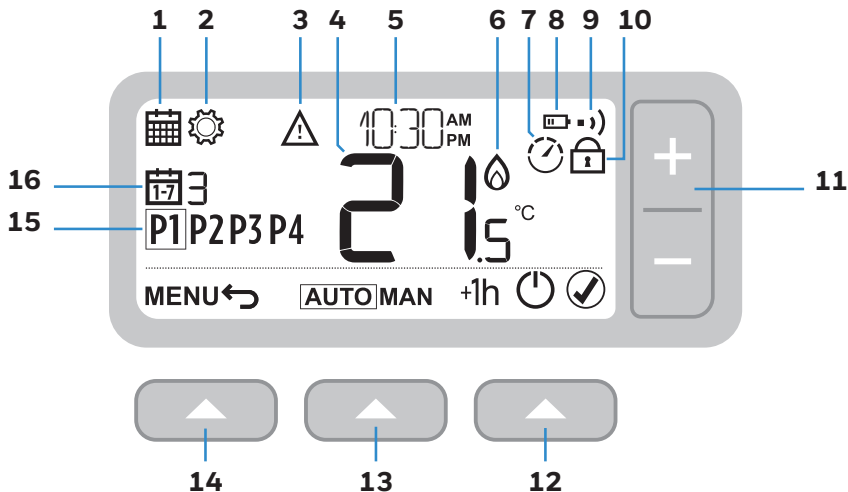





- 1** Programming Menu
- 2** Settings Menu
- 3** Alert
- 4** Room Temperature
- 5** Current time
- 6** Heat demand





- 7** Optimisation
- 8** Low battery
- 9** Wireless signal (T3R)
- 10** Keypad Locked
- 11** Temperature adjust
- 12** Right button

- 13** Middle button
- 14** Left button
- 15** Schedule period
- 16** Day







## Status Icons

-  **Temperature Override Active:** Displayed if the programmed temperature has been manually adjusted.
-  **Low Battery:** Power has reached approximately 10% (see Changing the Batteries on page 16).
-  **Heat Demand:** Room temperature is below setpoint - indicating there is a demand for heating (boiler activity might occur).
-  **Optimisation Active:** Only displayed if optimisation has been enabled in the installer settings.
- 1h** **1 Hour Override Active:** Temporary override has been set for one hour.
-  **Wireless Signal:** Thermostat (T3R only) is connected to the Receiver Box.

## Menu & Navigation Icons

- MENU** Options and settings of your Thermostat:
  -  Heating schedule
  -  Settings (Date & Time)
-  **Back:** Return to the previous screen/menu.
-  **Confirm:** Confirm a change or selection.
-  **Standby:** Turns the heating on or off.

## Navigating the Menu

- Press **MENU**  button to enter the main menu.
- Press **+** or **-** buttons to select a menu item - the selected item will flash.
- Press   to confirm the selection.
- Press **+** or **-** to adjust a setting and then press   to save the change and advance to next selection, or press   to go back to previous selection.

## 2 Menu

### 📅 Heating Schedule



Your Thermostat comes with the following default schedule. Follow the next steps to adjust heating schedule.

		P1	P2	P3	P4
Days 1 to 7 (Mon to Sun)	🕒	6:30	8:00	18:00	22:30
	🌡️	21°C	16°C	21°C	16°C

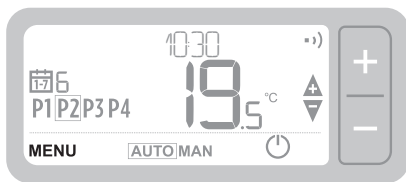

### Adjusting the Schedule

- 1 Press **MENU**  to enter the main menu.





- 2 Press **+** or **-** to select the schedule menu  and press  .



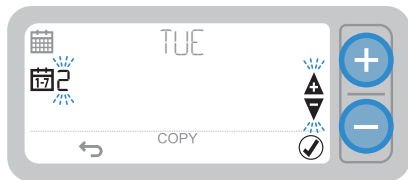

- 3 Press + or – to select the day to be adjusted and press  



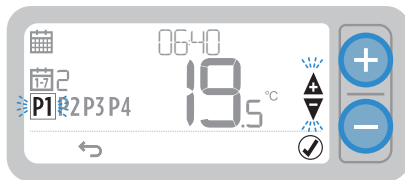

- 4 Press + or – to select the period to be adjusted and press  

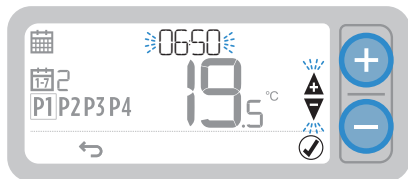

- 5 Press + or – to adjust the **time** and press  



- 6 Press + or – to adjust the **temperature** and press  

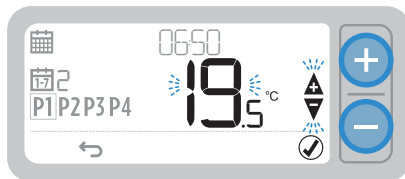



- 7 Repeat these steps to make adjustments to the remaining periods and days - or press   to save changes and return to the home screen.

## Copy Schedule

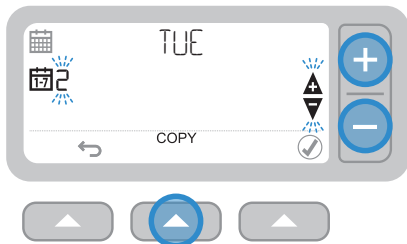
- 1 Press + or – to choose the day you want to copy the schedule **from** and press COPY 





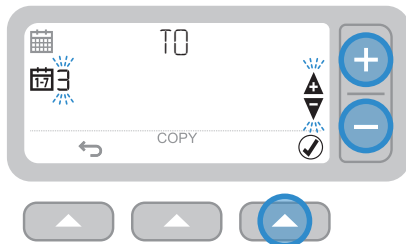

- 2 Press + or – to choose the day you want to copy the schedule **to** and press  

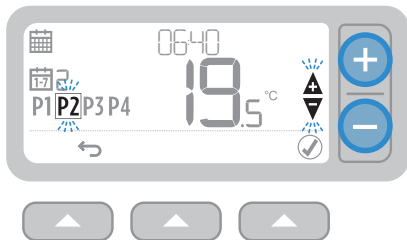

## Delete Period

- 1 Go to the day and choose the period to delete.



- 2 Press and hold the   for 3 seconds and then press  .

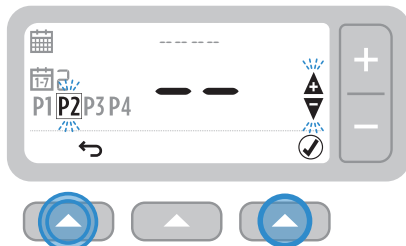





**3 seconds**

- 3 Repeat steps 1 and 2 to enable the period again.

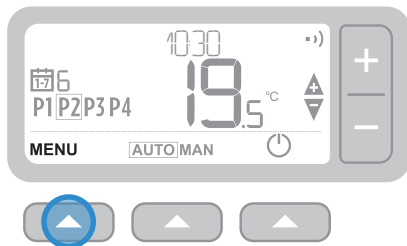
## Settings (Date & Time)

- 1 Press **MENU**  to enter the main menu.



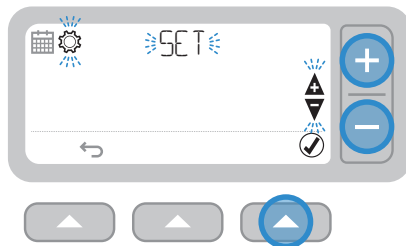

- 2 Press + or – to select the settings menu  SET and press  .

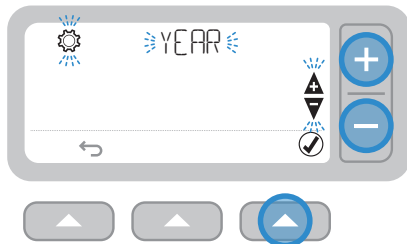

- 3 Press   to select YEAR (or + to skip forward to MONTH)



- 4 Press + or – to adjust the YEAR and press  .

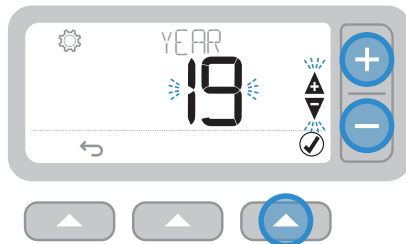



- 5 Press to select MONTH (or + to skip forward to DAY)

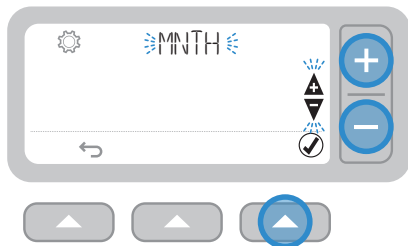

- 6 Press + or – to adjust the MONTH and press

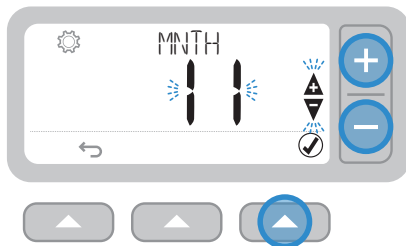

- 7 Press to select DAY (or + to skip forward to HOUR)

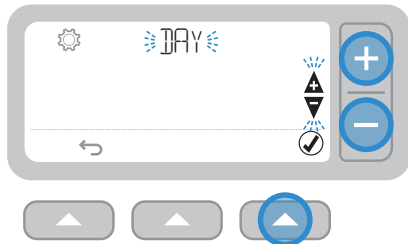

- 8 Press + or – to adjust the DAY and press

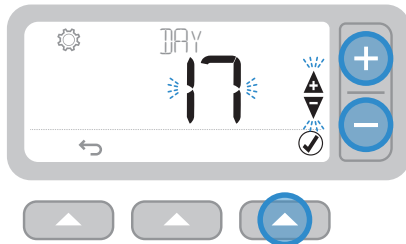

- 9 Press to select HOUR (or + to skip forward to MINUTE)

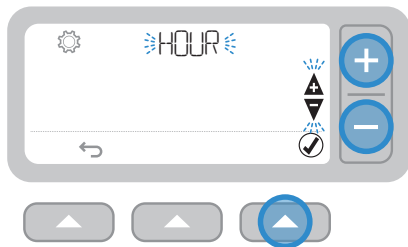

- 10 Press + or - to adjust the HOUR and press

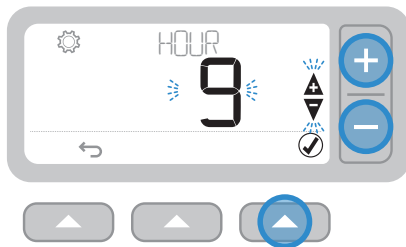

- 11 Press to select MINUTE and press

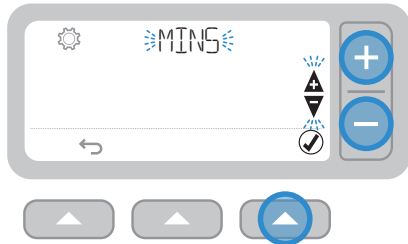

- 12 Press + or - to adjust the MINUTE and press

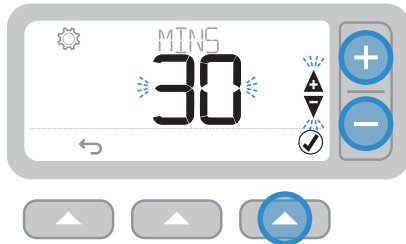

- 13 Press to exit SETTINGS and return to the home screen

### 3 Device Modes

#### **AUTO** Automatic Operation

During normal use your Thermostat will follow the programmed schedule - indicated by the **AUTO** icon.

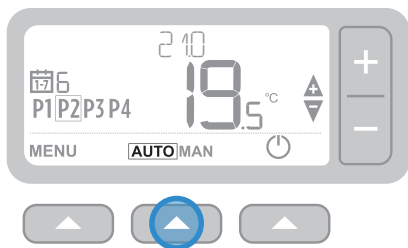

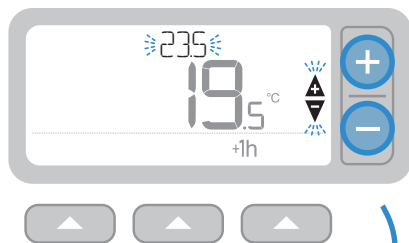

#### **Temporary override**

Press the + or - set the new desired temperature. The programmed schedule will resume at the next programmed setpoint.



#### **+1hr Timed override**

Press +1h  for a 1 hour timed override. Press +1h  again to cancel.

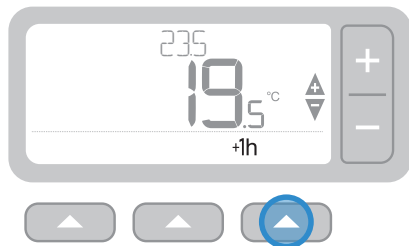

## **MAN** Manual Operation

The set temperature is followed permanently - indicated by the **MAN** icon.

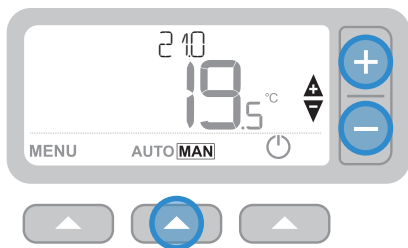

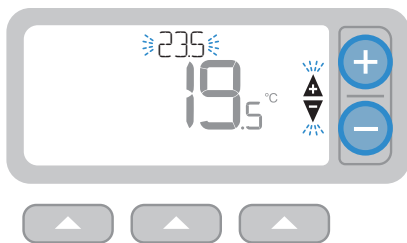

## **Permanent override**

Press the + or - buttons to adjust the set temperature. This temperature is set until manually changed again.



## Standby mode (with frost protect)

Save energy by switching the heating off when not required – e.g. during warmer summer months, or when doors and windows are open for extended periods of time. If the temperature drops to 5°C the heating will come on to prevent the heating pipes freezing.

- 1 Press  to switch the heating off - the display will show OFF
- 2 Press  a gain to switch the heating on - the display will show **AUTO** or **MAN**

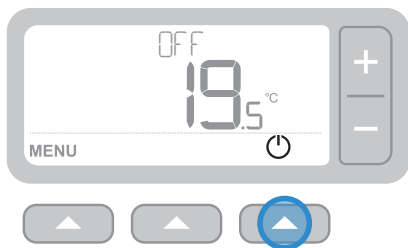

## 4 Keypad Lock

### Lock

Press and hold the Left & Right buttons for 5 seconds. The display will show the  icon and (depending on the installer setting) the Thermostat will have limited or no keypad functionality.

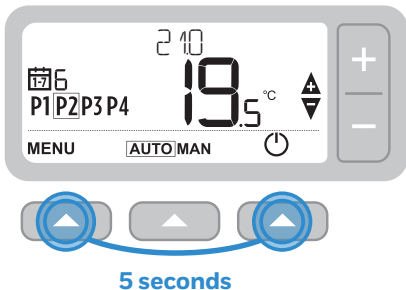

### Unlock

When the keypad is locked (indicated by the  icon) -Press and hold the Left & Right buttons for 5sec to restore the Thermostat's full keypad functionality.

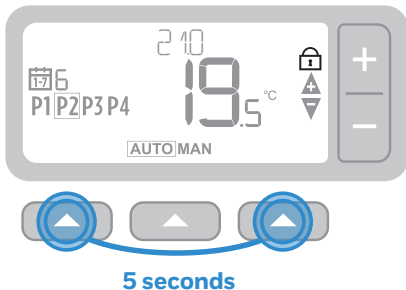

## 5 Optimisation





### Optimisation

Your Thermostat has optimisation functions that aim to save energy while maintaining suitable comfort levels. The Thermostat displays  during the optimisation period if set. By default optimisation is disabled, see instructions on installation guide on how to activate it.

- **Optimum Start** learns how long it takes your home to reach a set temperature and then turns the heating on a bit earlier to achieve that temperature at the programmed time.
- **Delayed Start** saves energy by slightly delaying the start of heating depending on the difference between the set temperature and the room temperature. The closer these temperatures are the longer it will delay the start.
- **Optimum Stop** saves energy by switching off a little bit earlier than the programmed time. If your home is up to temperature, you will not notice the effect on the temperature, but you should see a difference in your fuel bill.

## 6 Changing the Batteries (T3 & T3R only)

The Thermostat is powered by 2 x AA batteries, although a battery icon is not shown on the display during normal use. The only time you will see the battery icon is when they get low on power.

-  is displayed when battery power has reached approximately 10% - you should be prepared to change them soon.
-  +  will flash when battery power has become critically low - you should **change them immediately** to make sure there is no disruption to your heating system.
- Replace with 2 new **1.5V LR6 AA Alkaline** batteries only - which should last approximately 2 years depending on Thermostat use.

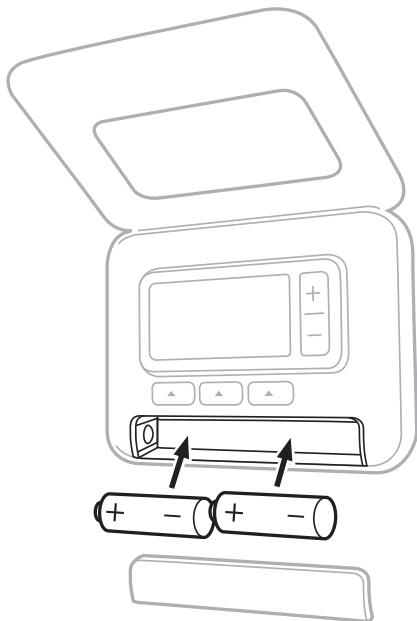

Please help to protect the environment by recycling old batteries in accordance with local regulations.



## 7 Table Stand and Wall Mount (T3R only)

### Table Stand

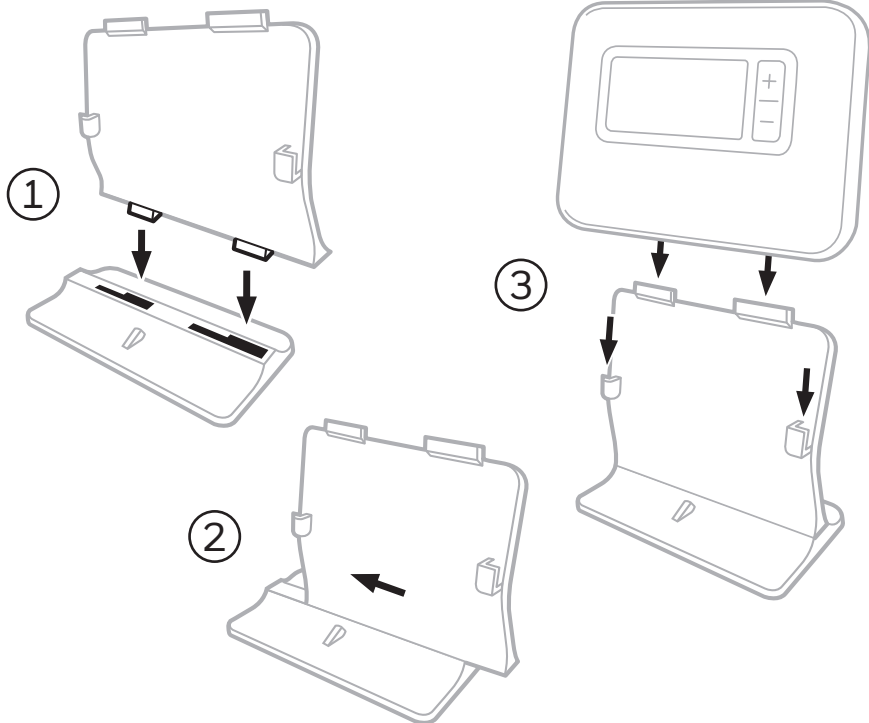

## Wall Mount

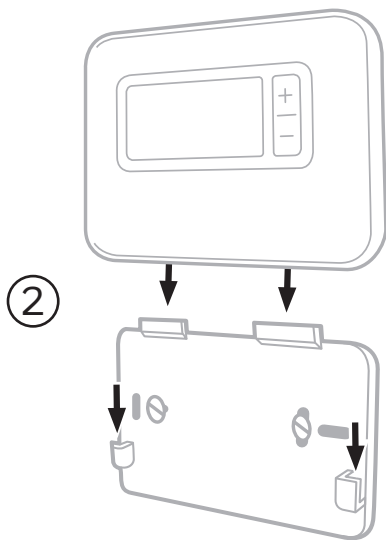
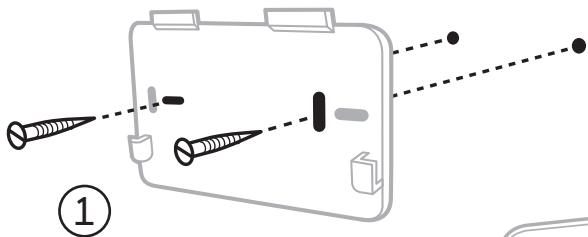

## 8 Wireless Receiver Box (T3R only)

The T3R Thermostat communicates wirelessly to the Receiver Box which is wired to the boiler. If the Thermostat loses wireless communication or becomes faulty, the boiler can be switched on or off manually using the button on the Receiver Box.

- **••)** is displayed on the Thermostat when the wireless signal is good - The receiver box **••)** LED will be solid GREEN.
- **△ + ••)** will flash on the Thermostat when the wireless signal is lost - The Receiver Box **••)** LED will flash RED.
- If communication is lost move the Thermostat to another location to try and restore communication.

To manually override the boiler using the Receiver Box:

1. Press the button **once** to switch the boiler ON or OFF. The button LED should be:
  - Solid GREEN when the boiler is ON.
  - Off when the boiler is OFF.

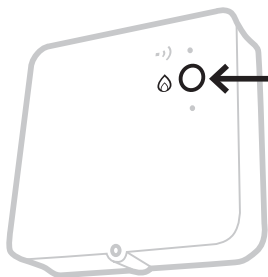







Press the button **once** to toggle boiler ON or OFF (leave at least 3 sec between each button press).



**Do not press the small reset 'pinhole' button** as this will clear the receiver box binding data and disrupt the operation of the heating system.

## 9 Troubleshooting

If you have difficulty with your Thermostat, try these suggestions. Most problems can be corrected quickly and easily.

<b>All models</b>	
Screen is blank	Replace the batteries (T3 & T3R only). Check the OpenTherm boiler has power (T3M only). Contact installer.
Thermostat shows 	Batteries have less than 10% power and need to be replaced soon.
Thermostat shows 	Batteries are critically low and need to be replaced immediately - see 'Changing the Batteries'.
Thermostat shows  but the boiler does not switch on.	The boiler cycles on and off as it controls the temperature, and sometimes the  icon will be displayed when the boiler has cycled off.  If the boiler doesn't switch on after a long period of time contact your installer.
Heating system does not respond to temperature adjustments.	Make sure the set temperature is higher than the actual room temperature. Check the heating system is powered on. Check the Receiver Box is powered and the Thermostat has a wireless signal (T3R only).
Thermostat shows 	The temperature sensor of your Thermostat is faulty, contact your installer to repair or replace the Thermostat.
	Boiler service reminder (UK Only). The boiler is due to be serviced. Please contact your landlord or local housing authority.

### T3R (Wireless) Thermostat & Receiver Box only

Thermostat is flashing $\Delta + \bullet$ ) and Receiver Box $\bullet$ ) LED is flashing RED.	Wireless signal lost - Move the Thermostat to another location to try and restore communication.
Thermostat is flashing $\Delta + \bullet$ ) and Receiver Box $\bullet$ ) LED is off.	Check Receiver Box has power by pressing the button to switch boiler on. If Receiver Box has power then no wireless binding data stored - Follow binding procedure in the installation guide or contact your installer.
Receiver Box $\bullet$ ) LED is flashing ORANGE.	Receiver Box is in binding mode - will time out of this mode after 3 minutes.

### T3M (OpenTherm) Thermostat only

An OpenTherm boiler can report alerts back to the Thermostat which can be useful when contacting an installer or maintenance engineer. You can view these in the 'OpenTherm® boiler alerts' menu.

Description	ID	Error code	OT Reading
Service request	001	01SR	0 = service not required 1 = service required
Low water pressure	002	02WP	0 = no WP fault 1 = WP fault
Gas/flame fault	003	03GF	0 = no GF fault 1 = GS fault
Air pressure fault	004	04AF	0 = no AP fault 1 = AP fault
Water Over Temperature	005	05WT	0 = no OVT fault 1 = OVT fault
OEM specific	006	06OS	Boiler manufacturer specific code



**resideo**

[www.resideo.com](http://www.resideo.com)

Country of origin: UK

©2019 Resideo Technologies, Inc. All rights reserved. The Honeywell Home trademark is used under license from Honeywell International Inc.